

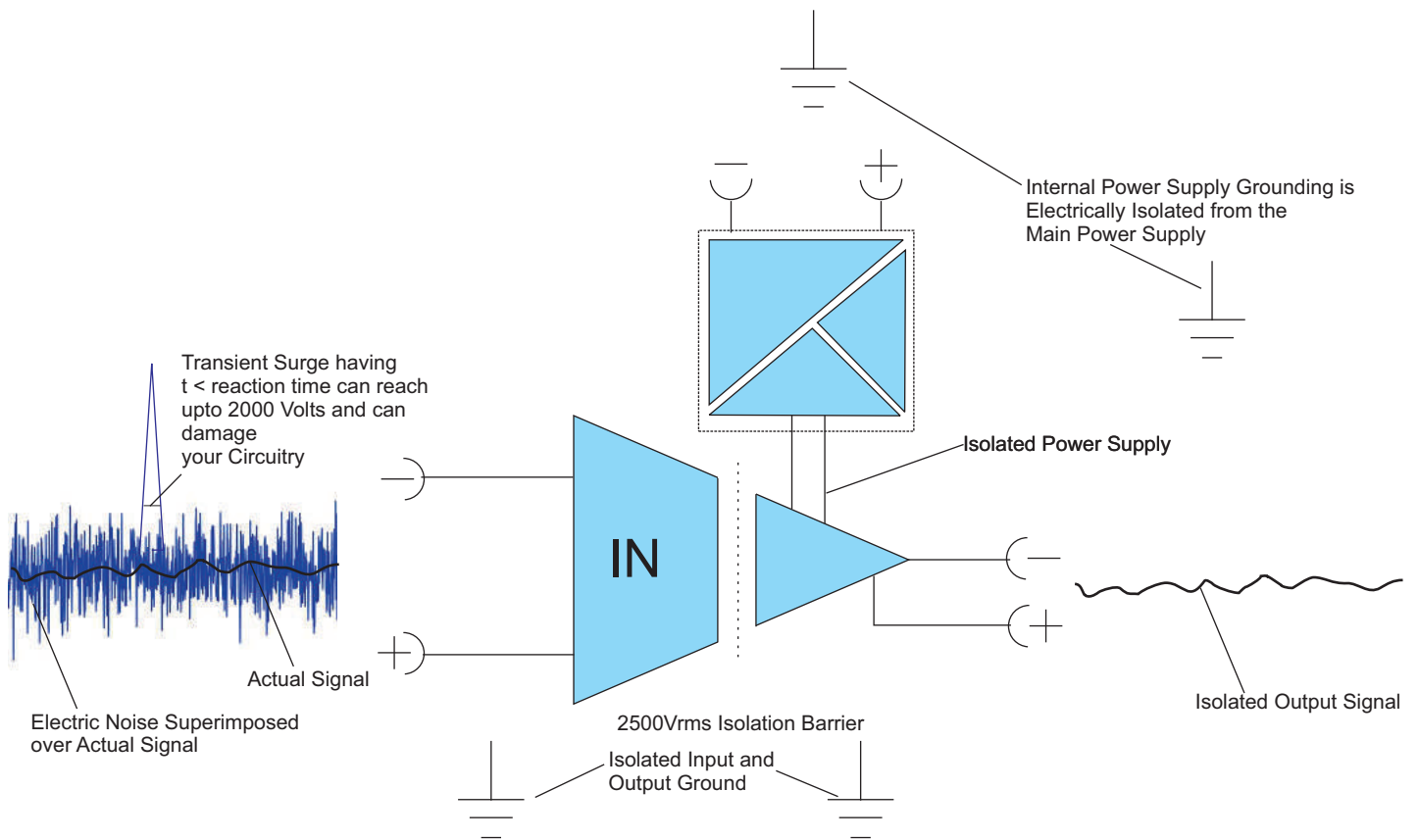

# YUTECH INSTRUMENTS

## Signal Isolators / Isolation Barriers



**Isolate and Protect your Automation System  
from  
all Electrical Problems**



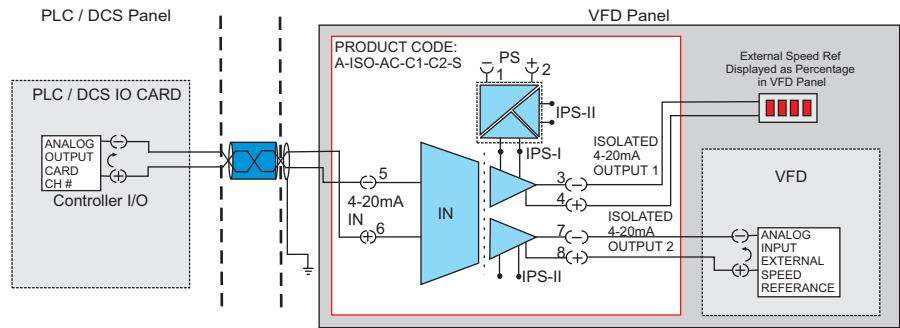
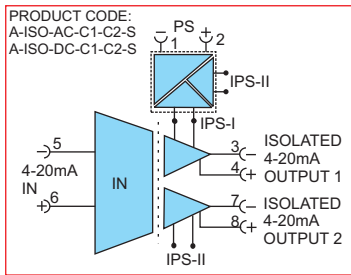

**SCHEMATIC AND APPLICATION DIAGRAM:** DC Current Isolator - Single Input Dual Outputs (Repeats the Input over Two Output Channels) VDC / VAC PS

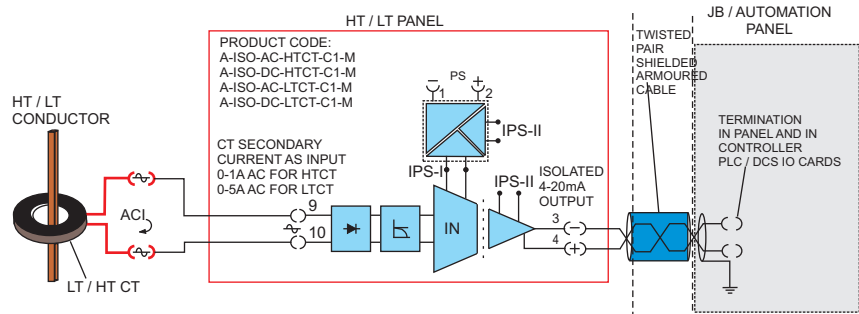
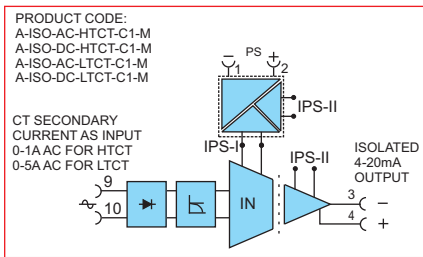

**SCHEMATIC AND APPLICATION DIAGRAM:** Isolating LT / HT CT Converter, 0-5A AC Input, 4-20mA Output, VDC / VAC PS

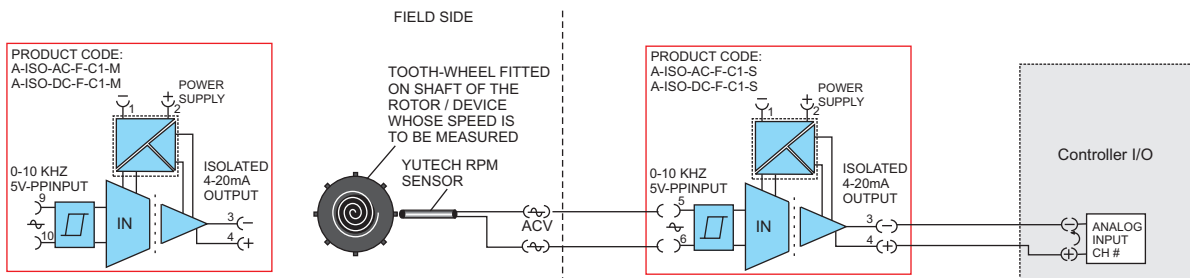

**SCHEMATIC AND APPLICATION DIAGRAM:** Isolating AC Signal Converter – Frequency (0-10KHz @ 5VPP), to Current (4 – 20 mA), VDC / VAC PS

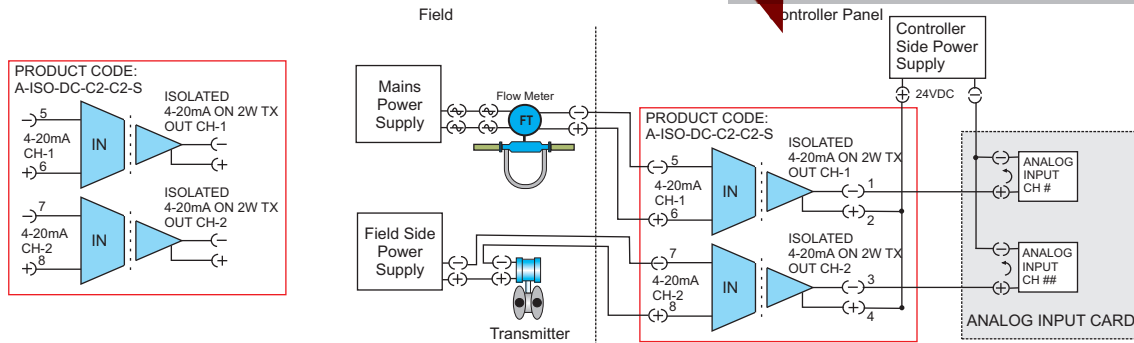

**SCHEMATIC AND APPLICATION DIAGRAM: DC Current Isolator - Dual Channel (Two independent Input and Output Channels) VDC PS (2 Wire Output)**

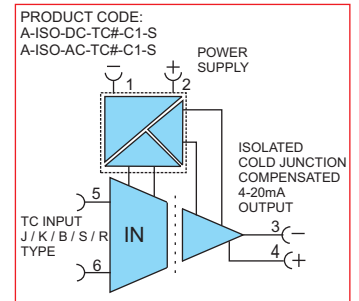
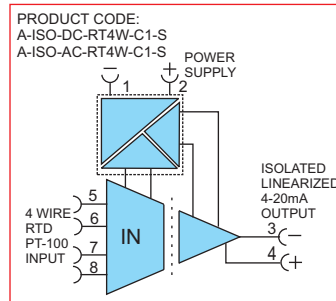
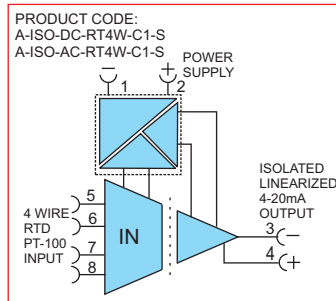
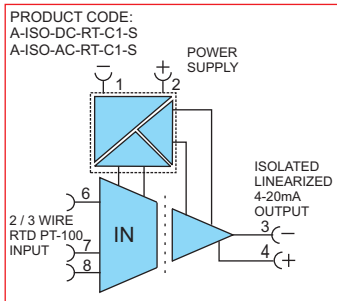

**SCHEMATIC AND APPLICATION DIAGRAM: Isolating Temperature Transmitters - Input: 2/3W RTD PT-100, 4W RTD PT-100, 4W RTD PT-1000, TC, Output: 4-20mA**

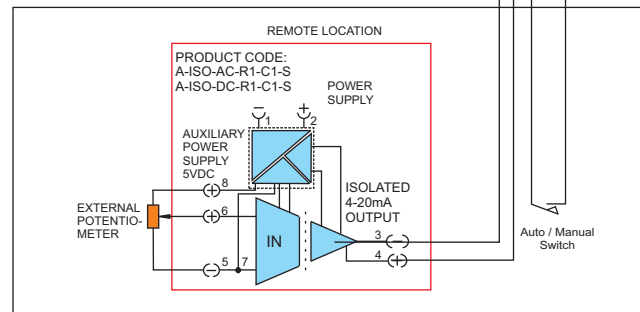
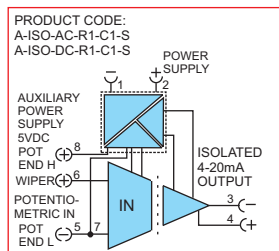
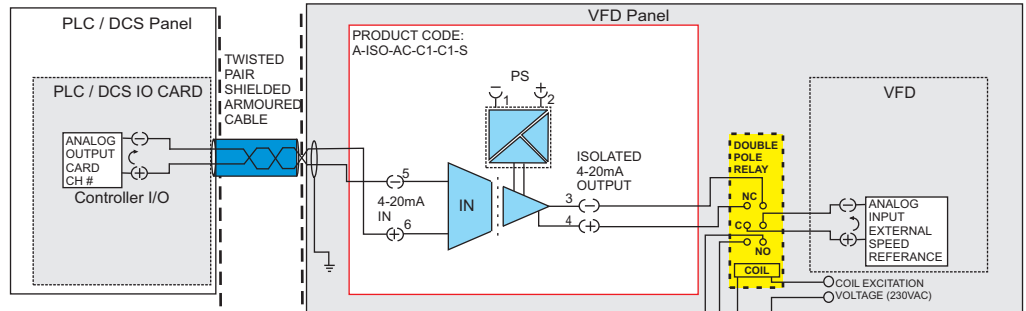
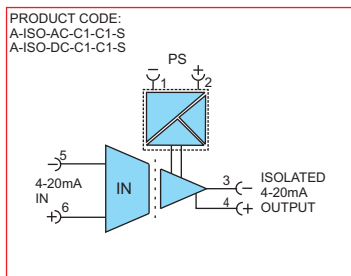

**SCHEMATIC AND APPLICATION DIAGRAM: DC Current Isolator and Isolating Resistance to Current Converter**

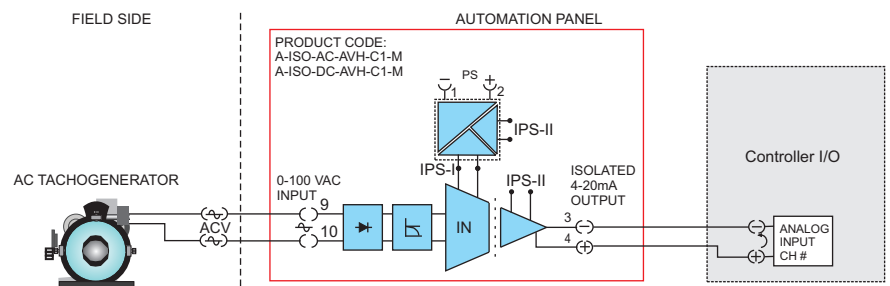
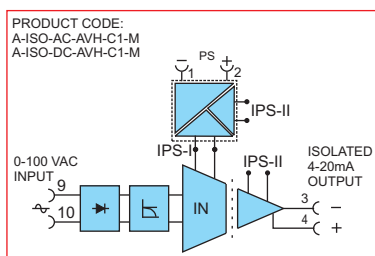

**SCHEMATIC AND APPLICATION DIAGRAM: Isolating AC Signal Converter - High AC Voltage (0-100VAC) to standard DC Current (4 - 20 mA), VDC / VAC PS**



# YUTECH

## ISOLATION PRODUCTS

DOC NO: YU-br-iso-instr-1005-1

**Product Code:** You can easily decode the product code (PC) as given below:

Example: Product Code of DC Current Isolator having Single Input and Output repeated over two Channels, having DC Power Supply is **A-ISO-DC-C1-C2-S**. If you require AC Power supply, then just replace DC with AC in the Product Code like **A-ISO-AC-C1-C2-S**.

### DC CURRENT ISOLATOR SINGLE INPUT DUAL OUTPUT

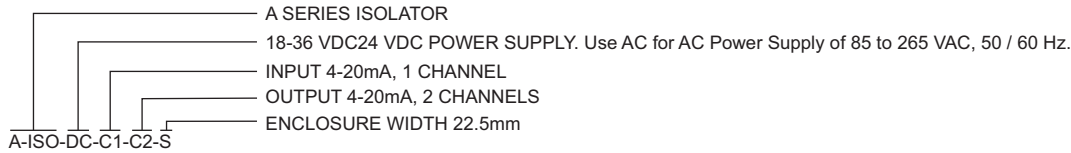

### Other Abbreviations:

S: Standard Din Rail mounted Enclosure 22.5mm wide

M: Medium Din Rail mounted Enclosure 45 mm wide

Use Isolation Barriers & get relief from Instrumentation and Automation Problems

Protect your Expensive Cards & Automation Systems from electrical noise like floating Voltages & Switching Surges and Electro-Magnetic Interference (EMI)

Eliminate Ground Reference Faults, Earth Loop Faults and Current Loop Faults

Eliminate Electrical Noise like Radio Frequency Interference (RFI), Common Mode Noise and Harmonic Distortion generated by Electric Motors, VFDs, DC Drives, Thyristors etc.

Ensure Correct & Stable Readings by Eliminating Separate Ground References.

PLEASE REFER TO ISOLATION PRODUCTS DATASHEETS AND APPLICATION NOTES FOR DETAILED INFORMATION ON PRODUCTS

Disclaimer: Isolation Products do not offer Protection against Lightning..



# YUTECH

## YU TECHNOLOGIES PVT. LTD.

Head Office & Works: B 8/5, Opposite Power Substation, MIDC, Miraj 416410, Dt. Sangli, Maharashtra, India.

T: +91 264 4042 | E: [info@yutech.in](mailto:info@yutech.in)

Sales: [sale@yutech.in](mailto:sale@yutech.in), Technical Support: [instruments@yutechglobal.com](mailto:instruments@yutechglobal.com)

W: [www.yutech.in](http://www.yutech.in)